

# 4 CHANNELS PID CONTROLLER PID QUADRO 96X96 DIN 1/4

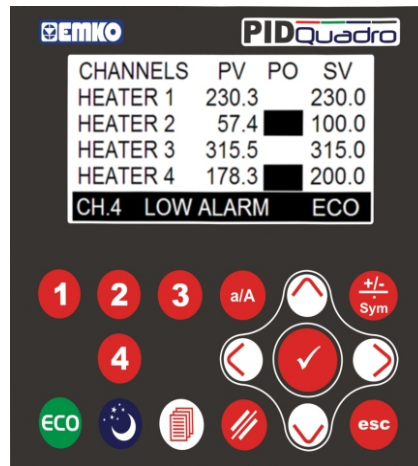

EPLC9600-PID QUADRO series 4 channels PID control devices are designed for measurement, control and temperature logging in of 4 different areas. It can be used in many applications with easy and advanced functions. The main application areas are; plastic, glass, petro-chemistry, textile, automotive, and machine production industries. It is specially preferable for extruder, plastic injection, thermoform machines, ovens, incubators.

## PIDQuadro 4 Zone PID Controller



ZONE 1 ZONE 2 ZONE 3 ZONE 4

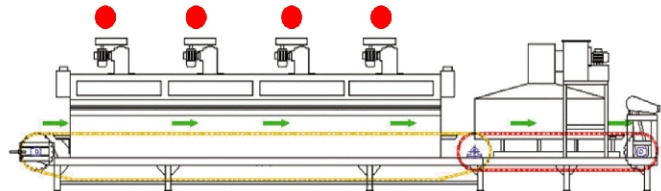

- 4 Thermocouple TC (J, K, L, R, vey S type ) or 4 RTD (PT-100) sensor inputs (optional)
- Sensor error detection
- Soft-Start (Ramp action during power on) spesification
- ECO and SLEEP mode selection.
- Adjustable temperature offset for each channel
- 3 different alarm types for each channel (High, low and band alarms)
- Operation with Real Time Clock(RTC)
- Local and Network communication with Modbus RTU communication protocol, also adjustment of the data record and the recording time with USB Flash Memory.
- 4 relay or transistor output
- 4 alarm (relay or transistor) output
- 1 main alarm output

# SOME OF THE IMPORTANT FEATURES OF THE PID CONTROLLER

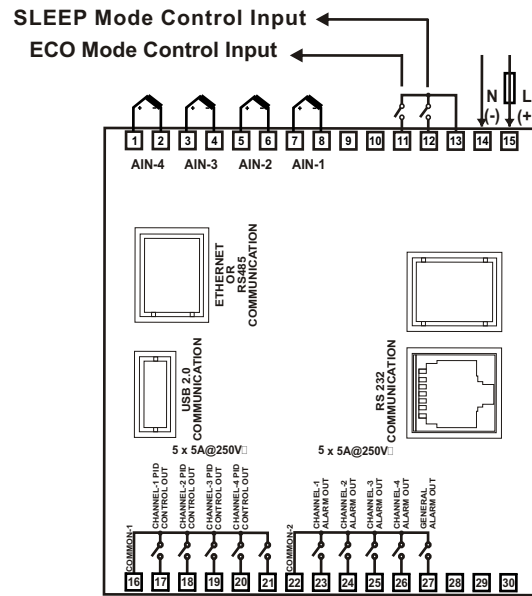
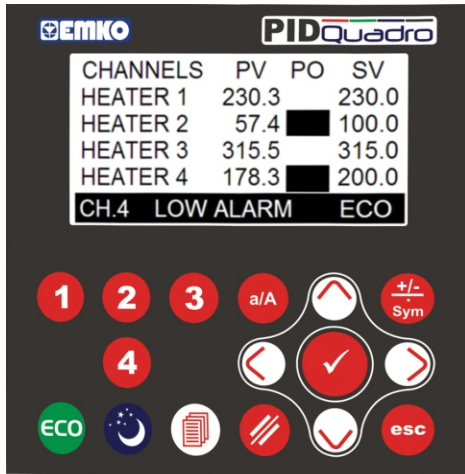

## ECO MODE :



When the ECO MODE activated device keep stable the %output power considering ECO MODE %output parameter value. Mode Activation is selectable such automatic, manual or digital input.

Automatic Mode : ECO MODE is activated automatically according to selected, date-time schedule and becomes deactivated at the end of periode.

Manual Mode : User press the ECO button on the device and decide to active or passive

Digital Input : ECO MODE is activated when the digital input on and becomes deactivated when the digital input off.

**If heating PID is selected , ECO MODE PROCESS SET = Process set - ECO SET Diff.**

**If cooling PID is selected , ECO MODE PROCESS SET = Process set + ECO SET Diff.**

**ECO :** If automatic mode active for the selected day, ECO MODE transition is made here. If parameter value

0 = Auto ECO MODE is disable for selected day of week

1 = Auto ECO MODE is enable for selected day of week

**MODE START HOUR :** If ECO MODE active for selected day of week, then auto ECO MODE starting hour is determined by this parameter.

**MODE START MINUTE :** If ECO MODE active for selected day of week, then auto ECO MODE starting minute is determined by this parameter.

**TIME:** If ECO MODE active for selected day of week, then auto ECO MODE activating time value is determined by this parameter.

**NOTE :** While the device in SLEEP MODE, ECO MOD can not be activated.

## SLEEP MODE :



**SLEEP MODE :** Device to be closed for a specified period by the user. Automatic mode, manual mode, or digital input can be selected.

**Automatic Mode :** SLEEP MODE is activated automatically according to selected, date-time schedule and becomes deactivated at the end of period.

**Manual Mode :** User press the SLEEP button on the device and decide to active or passive

**Digital Input :** SLEEP MODE is activated when the digital input on and becomes deactivated when the digital input off.

**SLEEP :** If automatic mode active for the selected day, SLEEP MODE transition is made here. If parameter value.

0 = Auto ECO MODE is disable for selected day of week

1 = Auto ECO MODE is enable for selected day of week

**MODE START HOUR :** If SLEEP MODE is active for selected day of week, than auto Sleep Mode starting hour is determined by this parameter.

**MODE START MINUTE :** If SLEEP MODE is active for selected day of week, than auto Sleep Mode starting minute is determined by this parameter.

**TIME:** If SLEEP MODE active for selected day of week, then auto SLEEP MODE activating time value is

**NOTE:** While the device in normal mode or ECO Mode, SLEEP MODE can be activated.

## SENSOR BREAK PROTECTION

In case of failure, device show (---) error message on the display and it gives the output until the %output power. it warns the user by signaling.

**Sbou :** The sensor has been lost output value. Device may takes a value between 0% and 100%. Device gives output previously entered by the user until is the %output power While will be any problem of the sensor connection and it continues until the new sensor is connected. So it protects the product in to the system.

## SOFT - START

If SOFT-START is activated using a described time (SOFT-START time), when the system power on device gives proportional %output beginning from ambient degree till reaching to process set. Reaching time is a linear schedule and soft start is deactivated at the end of this time period. So the device protects raw material in the progress and the system such drivers, invertors are protected against overload also using less power consumption.

## ALARM TYPES

There are 3 different alarms on the device that can be selected for each channel. If any channel value comes to the alarm level, alarm will be activated. High alarm, Low alarm and Deviation Band Alarm is available.

## HIGH ALARM

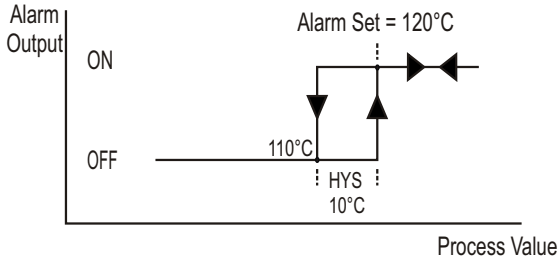

## LOW ALARM

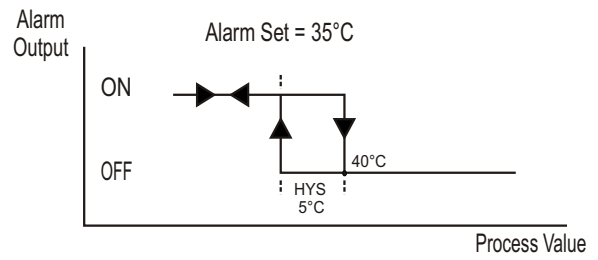

## DEVIATION BAND ALARM

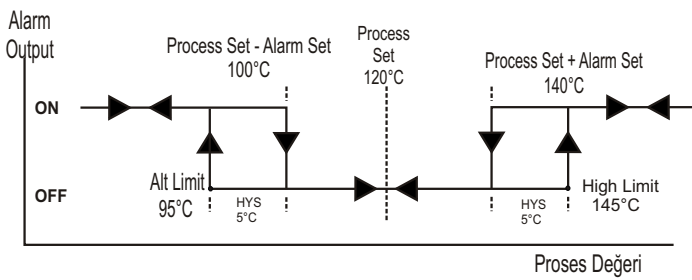

**Process Set - Alarm Set ≤ Process Set ≤ Process Set + Alarm Set**

**NOTE :** If HYS value is "0" deviation band alarm control algorithm is Process Set - Alarm Set and Process Set + Alarm Set.

## UNLIMITED COMMUNICATION WITH MODBUS RTU and USB DATA STORAGE



The user can establish local and ethernet communication between the device and the PC with MODBUS RTU. User can connect to the device by remote access from another city or another country and observe change all parameters. USB memory stick has a data storage for the process value / time / file name. Data logs can be saved with different files, unit add the saving time on each new line.

## REAL TIME CLOCK

Device allows you to set year, month, day, hour, minute, second with RTC. so the ECO MODE and Sleep Mode are programmable weekly monthly and yearly by the user.

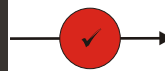
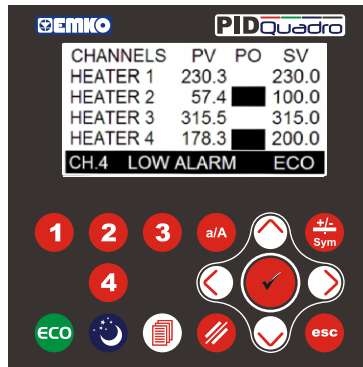

Press and hold on 3 seconds Enter button for setting the RTC time value

Parameter	Description	Unit	Min.	Max.	Default
YEAR	Year Value For RTC Time	-	2010	3000	-
MONTH	Month Value For RTC Time	-	1	12	-
DAY	Day Value For RTC Time	-	1	31	-
HOURL	Hour Value For RTC Time	-	0	23	-
MINUTE	Minute Value For RTC Time	-	0	59	-
SECOND	Second Value For RTC Time	-	0	59	-

